

# Wire rope hoists \_ field-proven technology, maximum flexibility



STAHL CraneSystems | Lifting technology | Drive technology | Control technology

# Competence from STAHL CraneSystems

**Experienced** Over 130 years of tradition, over 130 years of practical approach, competence and experience. STAHL CraneSystems can look back on a history characterised by the constant impetus to innovation and significant modernisations. Revolutionary and programmatic in many fields, always receptive to new aspects, we have amassed a wealth of experience that gives us a considerable lead today. You as our customer profit from this lead, from the know-how of one of the world's top-ranking manufacturers of components and systems for overhead transportation. As regards technology and cost-effectiveness, our products belong to the top flight internationally. Our service is individual, customer- and practice-oriented.



- 1876** | Company founded by Raphael Stahl
- 1903** | First electric pulley block
- 1922** | Development of electric hoist with wire rope and drum
- 1952** | Series production of Type C electric wire rope hoists
- 1978** | AS range of wire rope hoists
- 1998** | The new generation – SH range of wire rope hoists
- 2004** | SHW 8 winch launched

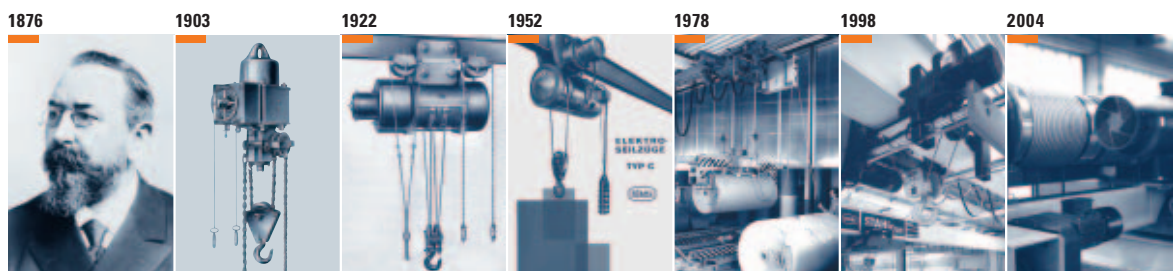



## 04 \_ Wire rope hoists

---



## 06 \_ SH wire rope hoist

---



## 08 \_ Technical features

---

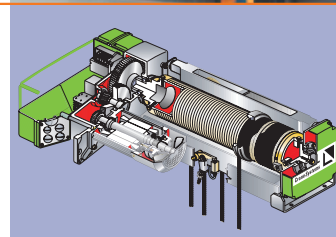

## 10 \_ AS7 wire rope hoist

---



## 12 \_ Equipment

---



## 14 \_ Explosion-protected wire rope hoist

---



## 15 \_ Service

---



National approvals – National approvals for the world economy's important growth markets are available for wire rope hoists from STAHL CraneSystems, inter alia for Canada, Russia, China and South Korea.

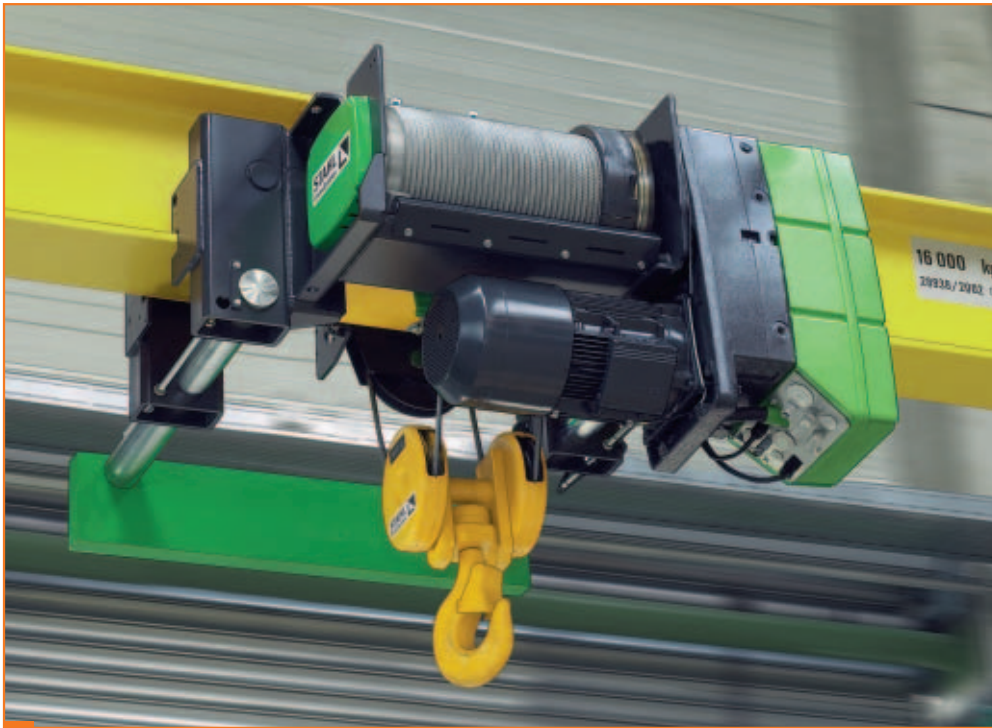

1

- 1 KE monorail trolleys with SH series wire rope hoists are available for S.W.L.s up to 25,000 kg.
- 2 The AS7 wire rope hoist supplements the SH series of wire rope hoists in the upper S.W.L. range up to 100,000 kg.
- 3 The innovative SHW 8 heavy duty winch is used for loads from 32,000 kg. Maximum safety is ensured by the optional redundant design of the brakes.
  - Ask for our special brochure!

2

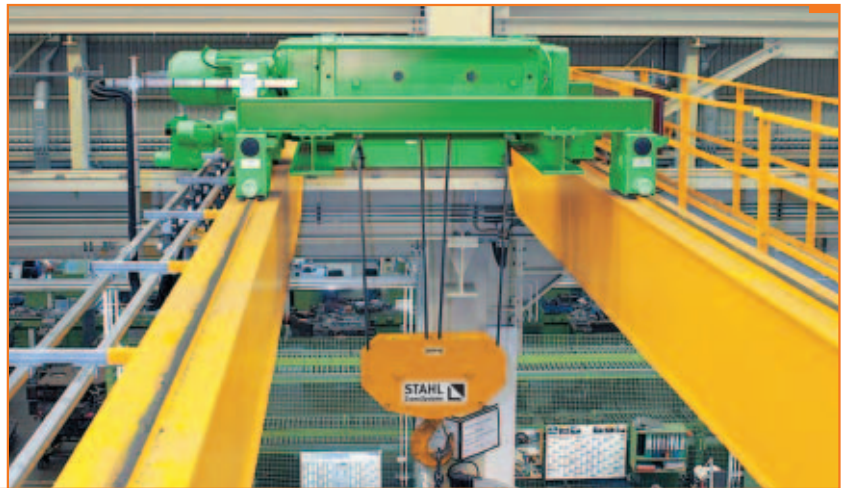

3

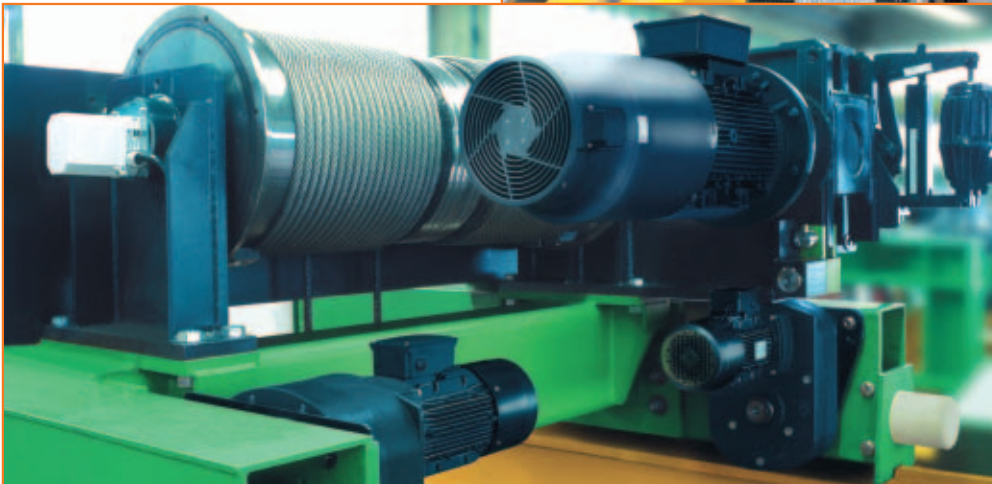

# Wire rope hoists \_ systematic variety

## High-performance

The adaptable wire rope hoists from STAHL CraneSystems are designed as an uncompromisingly modular system and calculated for an S.W.L. range from 500 kg to 160,000 kg. The modular system ensures rationalised production at the highest level of quality and maximum flexibility. The versatile SH series is available for the S.W.L. range from 500 kg to 25,000 kg in five frame sizes with 26 S.W.L. variants. The upper S.W.L. range up to 100,000 kg is covered by the tried-and-tested AS 7. The SHW 8 winch programme extends the area of application into the heavy load range up to 160,000 kg. A compact, sturdy construction is concealed behind the attractive design of STAHL CraneSystems' wire rope hoists. They are extremely reliable, extremely powerful and have above-average service life. The particularly smooth, precise starting and braking characteristics are common to all.

- › **Progressive** \_ Condition monitoring devices ensure safe operation. Electronic motor and brake management guarantees long service life.
- › **Matched to demand** \_ the most comprehensive wire rope hoist programme for the S.W.L. range from 500 kg to 160,000 kg
- › **Safe** \_ all wire rope hoists are available in  -protected design
- › **Powerful** \_ two hoisting and two travel speeds are standard
- › **Long-life** \_ particularly high classification in acc. with FEM

■ Standard    □ Option

Type	S.W.L. up to [kg]	Single reevings	True vertical lift reevings	Stationary	OE double rail crab	KE	UE	DKE
						monorail trolleys		
SH 3	3.200	1/1, 2/1, 4/1	2/2, 4/2	■	■	■	■	■
SH 4	6.300			■	■	■	■	■
SH 5	12.500			■	■	■	■	■
SHR 6	16.000			■	■	■	□	□
SH 6	25.000	2/1, 4/1, 6/1, 8/1	2/2, 4/2, 8/2	■	■	■	□	□
AS 7	100.000			■	■	□	□	□
SHW 8	160.000			–	4/2-1, 8/2-1, 12/2-1	■	■	

- 1 | Power station – SH 60 wire rope hoist with UE monorail trolley, 0 true vertical lift, lifting height of 75 m  
 → Ask for our reference brochure ›Power stations!
- 2 | At an equipment supplier for the motor industry, SH wire rope hoists in combination with single girder overhead travelling cranes are used for handling apparatus.
- 3 | Railway construction – The three custom cranes with six SH 50 wire rope hoists have room to move in the large production building measuring 52 m x 85 m, and can be operated by a single radio remote control if required.  
 → Ask for our reference brochure ›Railway construction!



- 4 | DKE articulated trolleys are used on runways with narrow curve radii. Equipped with guide rollers, they cause minimum wear when negotiating even narrow bends.
- 5 | Use as lifting and towing equipment, either stationary or mounted on trolleys. The rope drum can be single or double-grooved.
- 6 | The double-grooved version is available if true vertical lift is required.
- 7 | KE monorail trolley – For monorail runways and single girder cranes. The trolley headroom is extremely low, thus long hook paths are possible in low-ceilinged rooms.
- 8 | DKE articulated trolleys – These trolleys are used on runways with narrow radii of bend. (see Fig. 4)
- 9 | UE monorail trolley – For monorail runways and single girder cranes. The trolley width is extremely low, thus small clearance dimensions are possible.
- 10 | OE double rail crab – The extremely compact construction permits low approach and headroom dimensions. Various track gauges can be supplied for all S.W.L. ranges.

# The SH wire rope hoist

## Flexible

The SH range from STAHL CraneSystems is a world-wide optimum in crane and hoist technology, compact, powerful and particularly maintenance-friendly. Users, crane manufacturers and system manufacturers appreciate the modular system, built up on the basis of tried-and-tested, low-maintenance series components. This varied range permits use in individual solutions thanks to the practically unlimited combinations of the modules. The SH range from STAHL CraneSystems is available for the S.W.L. range from 500 kg to 25,000 kg in five frame sizes and 26 S.W.L. variants. They can be used as stationary hoists or complete with trolleys or crabs on standard cranes, custom cranes or in systems manufacture. The SH wire rope hoist programme is naturally also available in explosion-protected design for Zone 1, Zone 2, Zone 21 and Zone 22.

- › **Universal** \_ five frame sizes with 26 S.W.L. variants
- › **Flexible** \_ stationary models and trolleys in flexible configurations, for cranes and systems manufacture
- › **Compact** \_ the ›U‹ shape results in a short overall length
- › **Cost-effective** \_ practically maintenance-free, low wear, long life
- › **Demanding** \_ high-quality safety components as standard for increased safety at work
- › **Safe** \_ available as an option in -protected design in compliance with ATEX

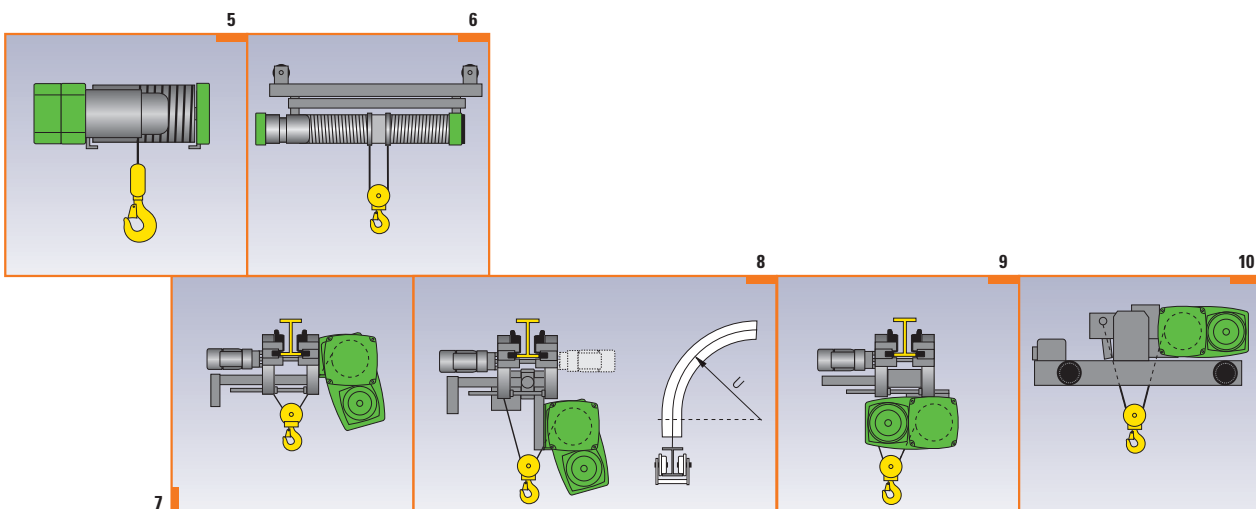

# Perfect technology in detail

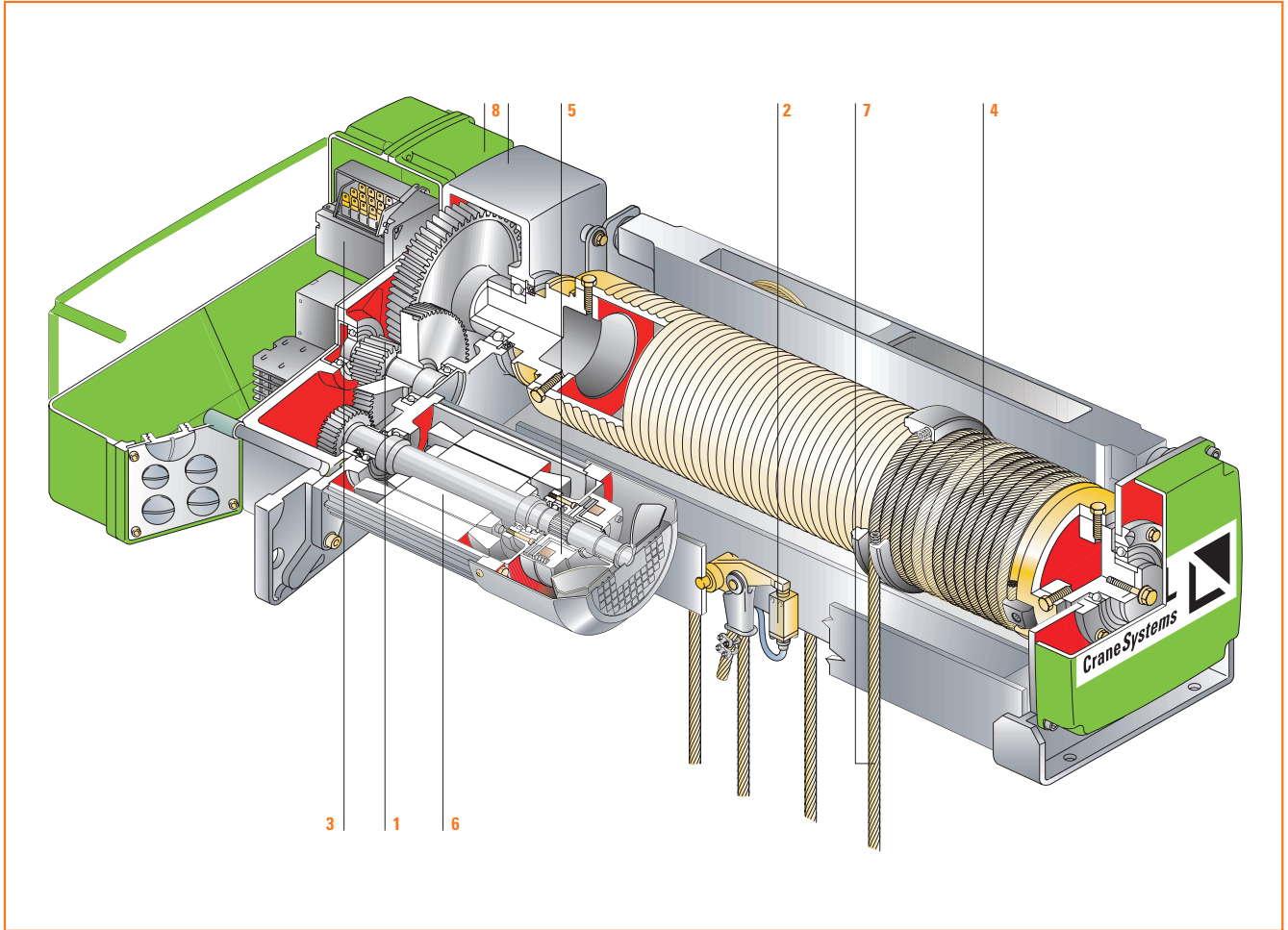

## 1 Hoist gear

- › All gear steps with lifetime oil bath lubrication
- › trouble-free operation, maintenance-free for many years
- › Minimum noise emission thanks to up-to-date technology



## 2 Overload cut-off

- › Continuous electronic monitoring of the loads on the hook
- › Limiting of maximum load by means of electronic overload cut-off in the rope suspension
- › For systems manufacturers: overload cut-off possible even with 1/1 or 2/2 reevings by means of load measurement





### 3 SLE control and motor management

- › Condition monitoring as standard equipment reduces wear and the stress of inching operation
- › All common control voltages available
- › Optimised safety provided by oversized contactors
- › Type of protection IP55



### 4 Rope guide

- › Tried-and-tested enclosed rope guide in cast iron (GGG 40)
- › GGG 40 material is suitable in high temperatures and if faulty operation causes the rope to be pulled at an angle
- › 360° rope tensioning device, formation of slack rope is avoided



### 5 Motor

- › Special motors for hoist applications
- › 4 m classification in acc. with FEM, high duty cycle and switching frequency
- › Type of protection IP55, insulation class F
- › Motor outside drum, extremely efficient cooling of motor, maintenance-friendly
- › Temperature control by PTC thermistors

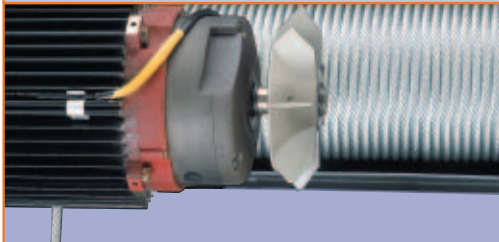

### 6 Brake

- › Low-maintenance, asbestos-free brake; no adjustment necessary
- › Long service life ensured by oversized braking torque
- › Brake easily accessible from outside
- › Low-wear thanks to electronic brake control
- › Type of protection IP 65



### 7 Rope drive

- › Optimised ratio of drum to sheave diameters ensures minimum wear on the rope
- › Flexible and long-life wire rope
- › True vertical lift optionally available
- › Drum freely accessible for replacing rope
- › Flexible rope exit angles for multi-hook applications



### 8 Paintwork

- › Standard paint shade yellow-green, RAL 6018 and black-grey, RAL 7021
- › High-quality primer and topcoat paint for standard applications
- › Off-standard paints for outdoor use or corrosive environments
- › Paint shade to customers' specifications

1 | BMW – These AS 7 wire rope hoists are equipped with maintenance platforms to permit safe maintenance work. The ramshorn hooks in the bottom hook blocks can be rotated electrically for precise handling of loads.

→ Ask for our reference brochure »Engine production«!

2 | SR Technics, Switzerland – This off-standard crane with an AS 7 wire rope hoist and an S.W.L. of 10,000 kg is installed in a hangar for maintenance work.

→ Ask for our reference brochure »Aircraft maintenance«!

3 | In the tool shop of a renowned automotive manufacturer, AS 7 wire rope hoists with no lateral hook movement for true vertical lift are in use. High S.W.L.s and lifting heights are required.

4 | Concrete manufacture – Frequency-controlled ASF 7 wire rope hoists lift a beam synchronously to store and retrieve 50 t stacks of concrete.

→ Ask for our reference brochure »Europe's largest storage and retrieval machine«!

1



2



3

# The AS7 wire rope hoist

## Tried and tested

The AS7 range from STAHL CraneSystems supplements the SH range in the upper S.W.L. range from 25,000 kg to 100,000 kg. This wire rope hoist is used as a stationary lifting or towing device or with crabs on bridge cranes or in systems. The narrow and compact construction is of particular advantage here, the overall width permits it to be used when space is restricted. On the AS7 wire rope hoist, motor, gear and rope drum are lined up behind one another on a common axis. This central gear concept permits high performance and high loads. The AS7 wire rope hoist programme is available as an option in explosion-protected design in acc. with ATEX for use in Zone 1, Zone 2, Zone 21 and Zone 22.

- **Up-to-date** \_ innovative drive technology in the form of cylindrical motor with monodisc magnetic brake
- **Flexible** \_ outstandingly suited for integration into material handling systems
- **Advantageous** \_ its construction with motor and drum on one axis permits it to be used in restricted spaces
- **Maintenance-friendly** \_ all important elements are easily accessible, lifetime lubrication of all gear steps in an oil bath
- **Safe** \_ available in -protected design in compliance with ATEX as an option

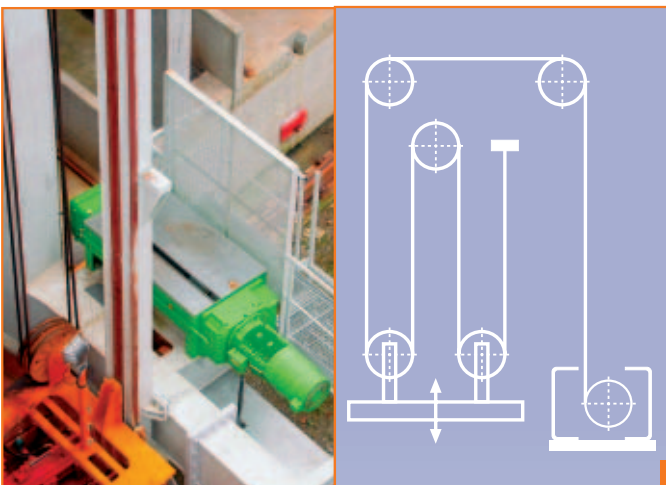

# Wire rope hoist equipment \_ greater safety, longer service life

**Impressive** The functioning and performance of wire rope hoists from STAHL CraneSystems are developed down to the smallest detail. Pioneering, high-quality original modules complement each other in the system. Over and above this, many forms of additional mechanical, electrical and electronic equipment offer still greater safety and cost-effectiveness and guarantee an extended service life of the wire rope hoists. The supplements to the programme permit the performance of the wire rope hoist to be individually adapted to customer-specific requirements and even increased. Various types of off-standard equipment which make working particularly convenient can also be selected.



## Radio remote control with feedback

- › Innovative, ergonomic construction with a choice of three transmitters
- › Signal feedback from crane to crane operator on an LC display. It includes for example display of the current load, information on operating conditions, load spectrum and remaining service life and the evaluation of operating data.
- › Electronic records for subsequent evaluation are also possible.



## Load display

- › Large-format, four-figure load display on hoist or crane
- › Seven-segment figures with a choice of figure heights of 60, 100 or 140 mm

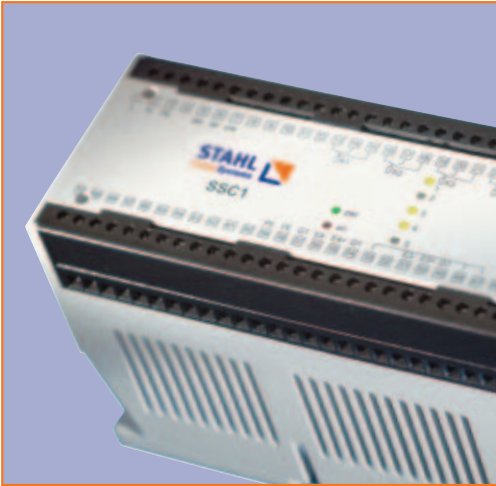

### SSC cumulative load control

- › The SSC cumulative load control adds up loads suspended on multiple hooks and disconnects the hoisting motion if the permissible load limit is exceeded.
- › Evaluating the load signals of a maximum of four single loads permits maximum safety when operating with more than one load hook.
- › Use of the flexible cumulative load control SSC increases the safety of material transport and prevents the crane being overloaded.

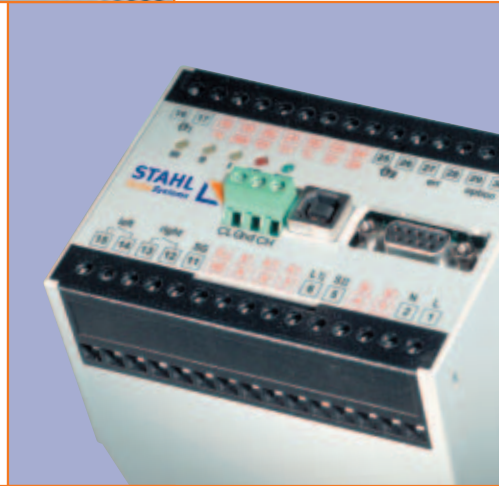

### SMC Multicontroller

- › The SMC Multicontroller is used if accurate operating data and maximum safety are required during crane operation.
- › The crane loads are continuously monitored by the ALC automatic load control.
- › The system also reacts if the load suspended on the hook changes.
- › The data can be transmitted to a standard PC via a USB interface and evaluated.

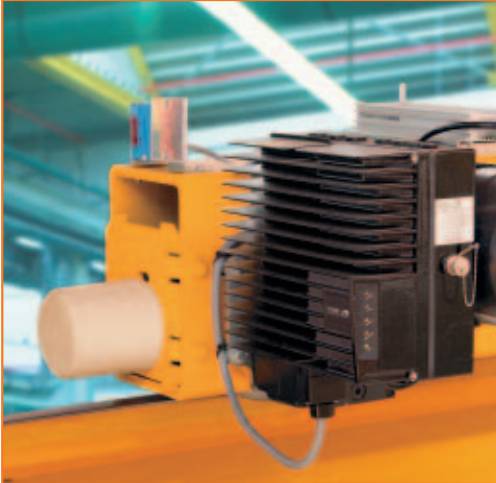

### SFD frequency inverter

- › The innovative, versatile frequency inverters for cross and long travel increase safety in overhead material handling.
- › Simple to install, parameterise and operate
- › Stepless acceleration and braking extend the lifetime of the system
- › Minimum load swing thanks to smooth starting and braking characteristics
- › Speed range can be adjusted, e.g. from 1:30 to 1:10
- › High duty cycle 60% DC



### Rope drum brake

- › Increased safety in foundries and other custom applications thanks to redundant braking system.
- › The drum brake is controlled by the SBC brake controller.



1



2

# Explosion-protected wire rope hoists



ATEX

## Extreme

STAHL CraneSystems is pioneering, dynamic and uncompromising when the safety of persons and machines in areas subject to gas and explosion hazards is at stake. All around the world, STAHL CraneSystems is regarded as a specialist for explosion protection. STAHL CraneSystems occupies a prominent position in this field with our many decades of experience and know-how, our own fundamental research and development, approvals from the Federal Physico-Technical Institute (PTB) and other test institutes in many countries. All components of STAHL wire rope hoists without exception come from our own production, from motor and brake to controls and control pendant. This ensures maximum and high-quality explosion protection. Naturally the new, strict ATEX regulations on mechanical explosion protection are met. STAHL CraneSystems was the first manufacturer of overhead material flow technology to implement the ATEX 100a directive 94/9 in the whole production range.

1 SH ex wire rope hoists are available for gas explosion protection Zone 1 and Zone 2, and for dust explosion protection Zone 21 and Zone 22. They safely meet the technical, normative and practical requirements made of them by ATEX.

A single girder overhead travelling crane with 5,000 kg S.W.L. is operated by radio remote control in a hazardous area in a chemical plant. Goods are transported over several storeys through a shaft.

- **Experienced** – the world’s leading specialist for explosion protection technology
- **Uncompromising** – everything from a single supplier and our own production
- **Pioneering** – design and maintenance in compliance with ATEX in certified quality
- **Complete** – the world’s first full hoist range for Zone 1 and Zone 2

# Customer services \_ all around the world, right around the clock

## Responsible

STAHL CraneSystems is a by-word for safety, confidence and cost-effectiveness. Our responsibility is to you, our customer. Specialists trained by us advise you on which hoists are right for your application. Planning, calculation and order processing are fast. The lasting safety and cost-effectiveness of your hoists and small crane systems are important to us at STAHL CraneSystems. In this too, qualified and competent service specialists, trained by us, look after your system throughout its service life, all around the world and right around the clock. Our services extend from world-wide prompt spare parts supply to individual, system-orientated maintenance using modern diagnostic apparatus, to annual inspections to ensure national accident prevention regulations are met. Training courses and seminars in our own training centre also form part of the extensive services offered by STAHL CraneSystems. We help your staff to keep up to speed.

- **On the spot** \_ 13 subsidiaries and over 100 partner companies around the world
- **Perfect** \_ Everything from one qualified supplier, STAHL CraneSystems
- **Competent** \_ Regular training courses for service engineers held by STAHL CraneSystems in our own training centre  
➔ [training@stahlcranes.com](mailto:training@stahlcranes.com)
- **Progressive** \_ Condition monitoring devices ensure safe operation, modern diagnostic apparatus permits customised service to be offered for the whole crane
- **Round the clock** \_ Online service for partners  
➔ [www.web.stahlcranes.com](http://www.web.stahlcranes.com)
- **Guaranteed** \_ Spare parts supply even decades after the series has been discontinued
- **Fast** \_ The electronic spare parts catalogue is a new medium for ordering spare parts

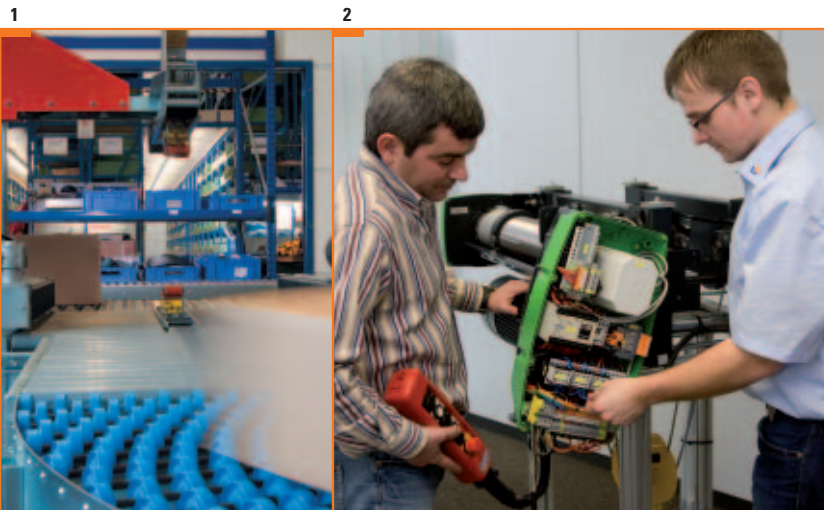

- 1 | Central spare parts warehouse in the Künzelsau-Hofratsmühle plant.
- 2 | Modern diagnostic apparatus assists service engineers during inspection and maintenance work.
- 3 | The electronic spare parts catalogue is a new medium for ordering spare parts.
- 4 | Regular training and information for service staff in the training centre.

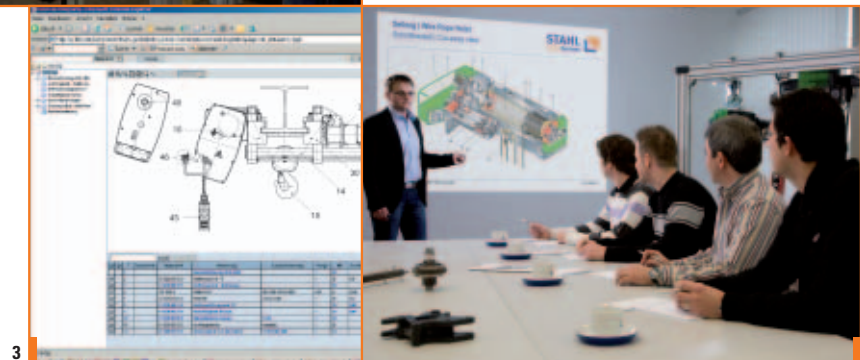

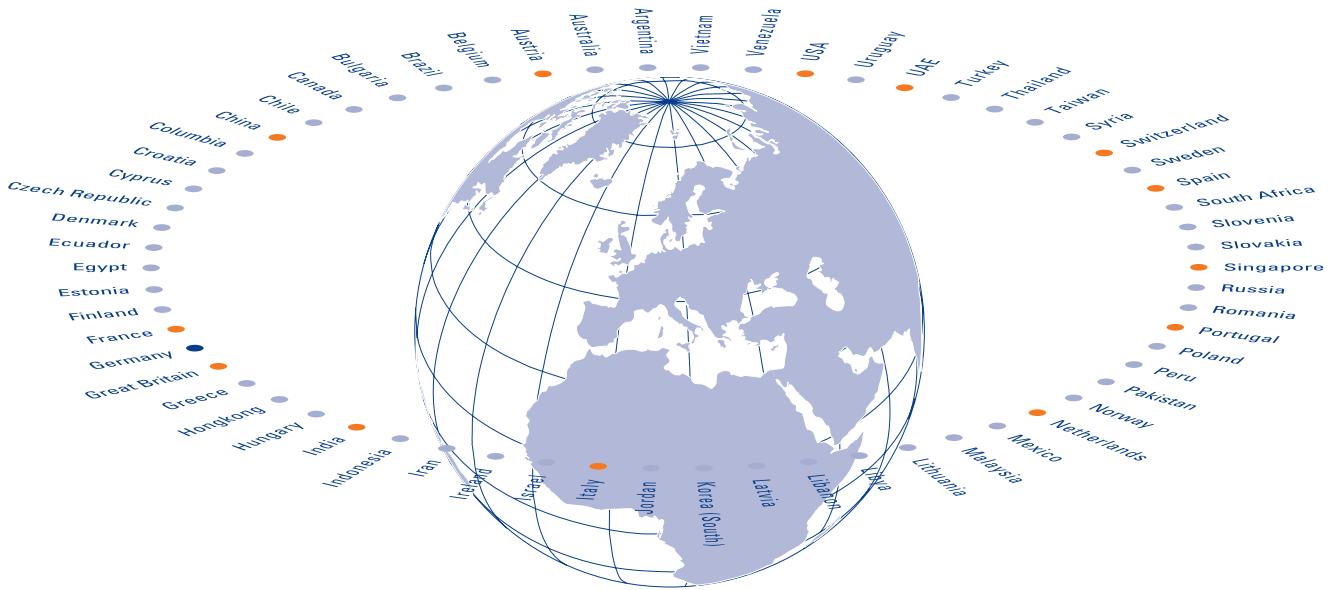

**● Subsidiaries**

**Austria**  
Steyregg  
Tel +43 732 641111-0  
Fax +43 732 641111-33  
office@stahlcranes.at

**India**  
Chennai  
Tel +91 44 43523955  
Fax +91 44 43523957  
anand@stahlcranes.in

**Singapore**  
Singapore  
Tel +65 6271-2220  
Fax +65 6377-1555  
sales@stahlcranes.sg

**USA**  
Charleston, SC  
Tel +1 843 767-1951  
Fax +1 843 767-4366  
sales@stahlcranes.us

**China**  
Shanghai  
Tel +86 21 62572211  
Fax +86 21 62541907  
victor.low@stahlcranes.cn

**Italy**  
S. Colombano  
Tel +39 0185 358391  
Fax +39 0185 358219  
info@stahlcranes.it

**Spain**  
Madrid  
Tel +34 91 4840865  
Fax +34 91 4905143  
info@stahlcranes.es

**France**  
Paris  
Tel +33 1 39985060  
Fax +33 1 34111818  
info@stahlcranes.fr

**Netherlands**  
Haarlem  
Tel +31 23 51252-20  
Fax +31 23 51252-23  
info@stahlcranes.nl

**Switzerland**  
Däniken  
Tel +41 62 82513-80  
Fax +41 62 82513-81  
info@stahlcranes.ch

**Great Britain**  
Birmingham  
Tel +44 121 7676414  
Fax +44 121 7676490  
info@stahlcranes.co.uk

**Portugal**  
Lisbon  
Tel +351 21 44471-61  
Fax +351 21 44471-69  
ferrometal@ferrometal.pt

**United Arab Emirates**  
Dubai  
Tel +971 4 8053700  
Fax +971 4 8053701  
info@stahlcranes.ae

**● Sales partners**

You will find the addresses of over 100 sales partners on the Internet at [www.stahlcranes.com](http://www.stahlcranes.com) under Contact

➔ [www.stahlcranes.com](http://www.stahlcranes.com)

STAHL CraneSystems GmbH, Daimlerstr. 6, 74653 Künzelsau, Germany  
Tel +49 7940 128-0, Fax +49 7940 55665, [marketing@stahlcranes.com](mailto:marketing@stahlcranes.com)

